

3000mm ± 50mm

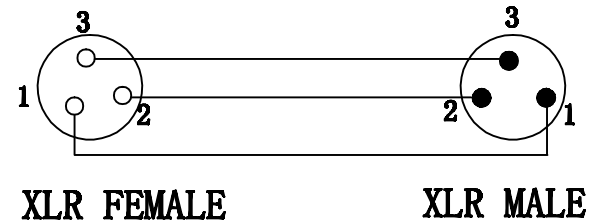
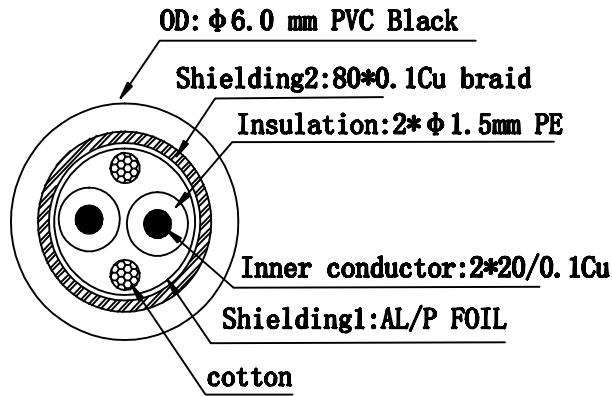
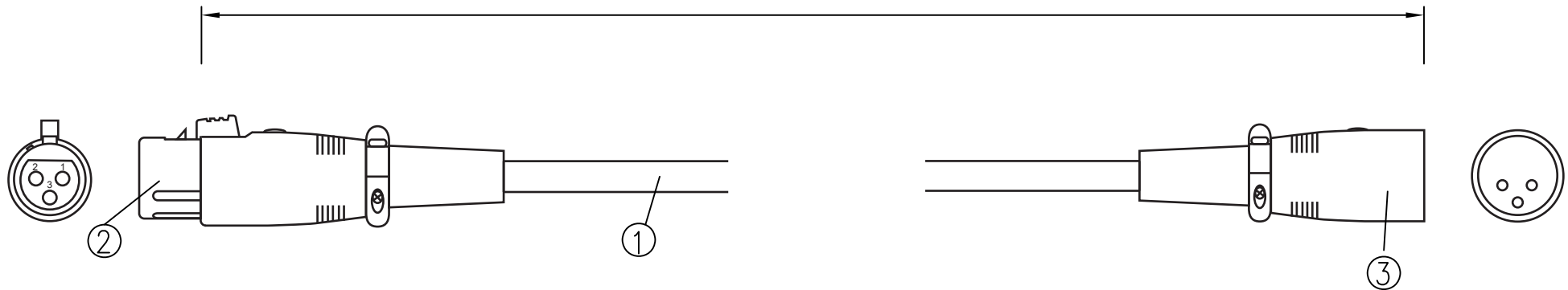

NOTE:

1. TESTING: 100% OPEN AND SHORT AND MISWIRE TEST.
2. CONDUCTION RESISTANCE: 5 OHM MAX
3. INSULATION RESISTANCE: 10 OHM MAX
4. WITHSTAND VOLTAGE: 300V
5. 100% ROHS REACH COMPLIANT

③	CONNECTOR 2	1PCS	XLR MALE Nickel plated
②	CONNECTOR 1	1PCS	XLR FEMALE Nickel plated
①	CABLE	1PCS	(26AWG*2P+ COTTON WIRE*2P)+AL/P FOIL+BRAID +BLACK PVC OD 6.0mm
NO.	PARTS NAME	Q'TY	SPECIFICATION

APPROVED	CHECKED	DRAWN	CUSTOMER	
			ITEM NO.	XLR-1030
			DRAW NO.	
			UNIT	mm
			SCALE	NONE

DESCRIPTION:

XLR CABLE
XLR FEMALE-XLR MALE

