

CLIFF

Simple and effective !



**A NEW
RANGE
OF 14 WALL
BRACKETS**

ERARD®

CLIFF range

A complete range for flat screens

**10 YEAR
GUARANTEE**



S 15"-23"
38-58cm **M** 19"-32"
48-81cm **L** 30"-50"
76-127cm **XL** 42"-65"
107-165cm

15" 23" 32" 42" 50" 65"

FIXED



CLIFF® **100**

043010

CLIFF® **200**

043020

CLIFF® **400**

043040

CLIFF® **600**

043060

TILTING



CLIFF® **100T**

043210

CLIFF® **200T**

043220

CLIFF® **400T**

043240

CLIFF® **600T**

043260

**TILTING AND
SWIVELING**



CLIFF® **100TW45**

043310

CLIFF® **200TW45**

043320

CLIFF® **400TW45**

043340

CLIFF® **100TW90**

043410

CLIFF® **200TW90**

043420

CLIFF® **400TW90**

043440

S 15"-23"
38-58 cm

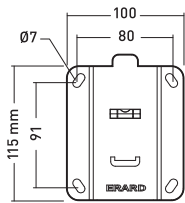

Wall mount

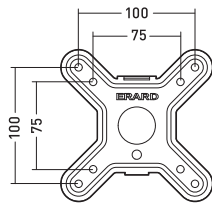

Mounting plate

CLIFF 100

For flat screens up to VESA 100

CLIFF 100

Ref. 043010



fixed



15" - 23"
38-58 cm



VESA
75,100



15 KG

CLIFF 100T

Ref. 043210



+5 / -15°



15" - 23"
38-58 cm



VESA
75,100



15 KG

CLIFF 100TW45

Ref. 043310



+25 / -25°
[19°]



+5 / -15°



15" - 23"
38-58 cm



VESA
75,100



15 KG

CLIFF 100TW90

Ref. 043410



+65 / -65°
[19°]



+5 / -15°



15" - 23"
38-58 cm



VESA
75,100



15 KG

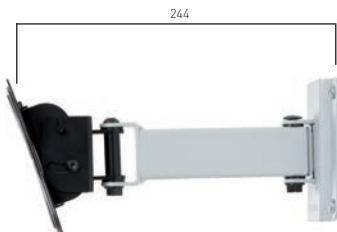

M 19"-32"
48-81 cm

CLIFF 200

For flat screens up to VESA 200

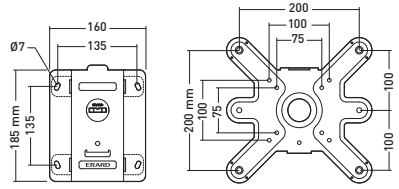

Wall mount

Mounting plate

CLIFF 200

Ref. 043020

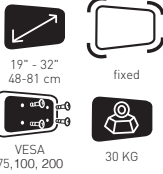

CLIFF 200T

Ref. 043220

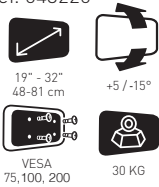

CLIFF 200TW45

Ref. 0433320

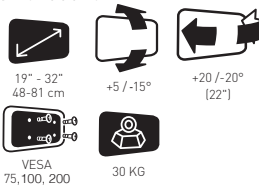

CLIFF 200TW90

Ref. 043420

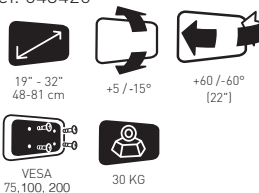

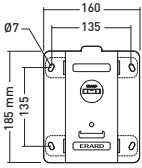

Wall mount

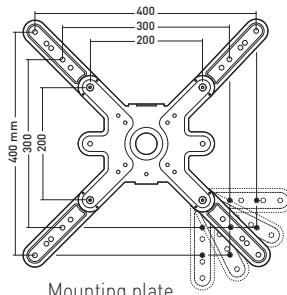

Mounting plate

L 30" - 50"
76-127 cm

CLIFF 400

For flat screens up to VESA 400



20

71

255

375

CLIFF 400

Ref. 043040



fixed



30" - 50"
76-127 cm



VESA
75>400



30 KG

CLIFF 400T

Ref. 043240



+5 / -15°



30" - 50"
76-127 cm



VESA
75>400



30 KG

CLIFF 400TW45

Ref. 043340



+40 / -40°
[32°]



+5 / -15°



30" - 50"
76-127 cm



VESA
75>400



30 KG

CLIFF 400TW90

Ref. 043440



+65 / -65°
[32°]



+5 / -15°



30" - 50"
76-127 cm



VESA
75>400



30 KG

XL 42" - 65"
107-165cm

CLIFF 600

For flat screens
up to VESA 600

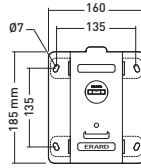

Wall mount

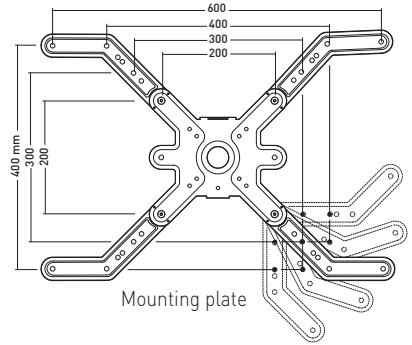

Mounting plate



CLIFF 600

Ref. 043060



fixed



42" - 65"
107-165 cm



VESA
75>600x400



30 KG



CLIFF 600T

Ref. 043260



+5 / -15°



42" - 65"
107-165 cm



VESA
75>600x400



30 KG



CLIFF merchandising



Packaging

POS

Ref.	043010	CLIFF® 100	EAN	318528 043010 9
Ref.	043020	CLIFF® 200	EAN	318528 043020 8
Ref.	043040	CLIFF® 400	EAN	318528 043040 6
Ref.	043060	CLIFF® 600	EAN	318528 043060 4
Ref.	043210	CLIFF® 100T	EAN	318528 043210 3
Ref.	043220	CLIFF® 200T	EAN	318528 043220 2
Ref.	043240	CLIFF® 400T	EAN	318528 043240 0
Ref.	043260	CLIFF® 600T	EAN	318528 043260 8
Ref.	043310	CLIFF® 100TW45	EAN	318528 043310 0
Ref.	043320	CLIFF® 200TW45	EAN	318528 043320 9
Ref.	043340	CLIFF® 400TW45	EAN	318528 043340 7
Ref.	043410	CLIFF® 100TW90	EAN	318528 043410 7
Ref.	043420	CLIFF® 200TW90	EAN	318528 043420 6
Ref.	043440	CLIFF® 400TW90	EAN	318528 043440 4



Catalogue Meubles et Supports
Mounts and Furniture catalogue



Catalogue Systèmes de fixations
pour antennes et paraboles
Mounting systems for
satellite dishes catalogue



Catalogue Systèmes de connexion
Connection systems catalogue



Catalogue ERARD Pro
ERARD Pro catalogue



ERARD®

ESSENTIAL ACCESSORIES
FOR AUDIO VIDEO COMPONENTS

WWW.ERARD.COM / Mail : INFOS@ERARD.FR / Tel : +33(0)4 72 46 16 26 / Fax : +33(0)4 72 46 16 22

VAT N° : FR 19 613 680 073

Z.I. de Chavanoz / 4 route de la Plaine / 38236 PONT DE CHERUY Cedex / FRANCE