

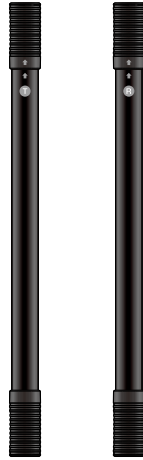

Multi-beam IR Sensors

AID-420

User Manual



Product Overview

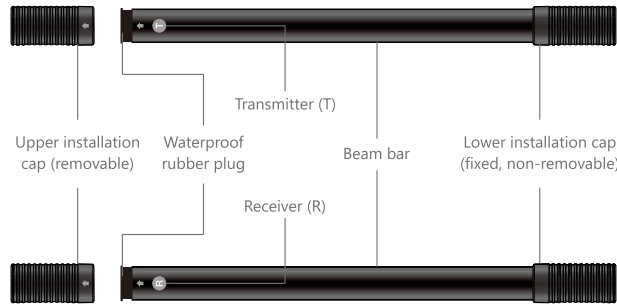

Transmitter Circuit Board

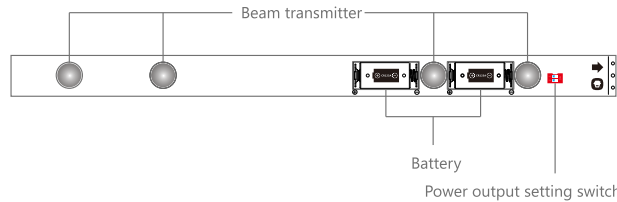

Receiver Circuit Board

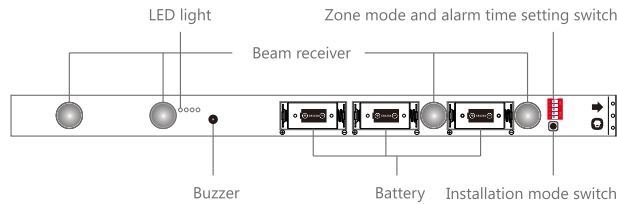

Low battery warning

The LED light blinks once every three seconds. When connected with a GSM or Wi-Fi control panel, the user will receive a text message or App push notification for low battery warning. Please replace the batteries as soon as you can.

Settings

Before the settings, remove the upper installation caps (marked ) and waterproof rubber plugs on both the transmitter and the receiver, pull out both circuit boards gently and insert the batteries (pay attention to the "+" and "-" polarity).

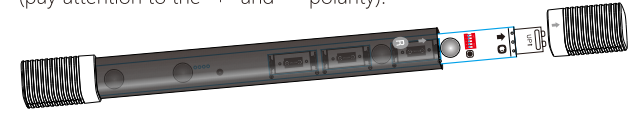

Power output setting

To set the output capacity, slide switch 1 of the power output setting switch to adjust.



High output setting



Low output setting

High output setting: $\geq 3m$ from the receiver
 Low output setting: $< 3m$ from the receiver

Zone mode setting

The zone mode types determine whether the control panel receives the alarm and responds accordingly. The zone mode setting can be adjusted by sliding switches 2 and 3 of the zone mode and alarm time setting switch.



24-H zone



Normal zone (Factory default)



Home mode zone

24-H zone: The IR sensors are in alert mode under all circumstances. Upon detecting any intrusion, the control panel immediately gives off an alarm.

It is best used for important areas that are usually not accessed.

Home mode zone: When the alarm system is armed, the IR sensors are on guard. Upon detecting any intrusion, the control panel immediately gives off an alarm. When the alarm system is disarmed or home armed, the control panel will not give off an alarm even the IR sensors are triggered.

It is best used for common areas where both family members and intruders have access.

Normal zone: When the alarm system is armed or home armed, the IR sensors are on guard, the control panel gives off an alarm immediately as the sensors are triggered. When the alarm system is disarmed, the control panel will not give off an alarm even the sensors are triggered.

It is best used for areas where intruders may have access, but family members have limited access.

Introduction

They are four-beam infrared sensors, widely used as a perimeter guarding device in gated houses, shops and indoor garages. The product requires to be paired to a control panel of our brand. When an intruder walks past the detection area and two or more light beams been blocked, the IR sensors will immediately send a warning signal to the control panel.

Packaging List



Transmitter x 1



Receiver x 1



CR123A Battery x 5



Screw pack x 1



Manual x 1

Alarm time setting

When two or more beams are blocked for the pre-set time, the IR sensors send an alarm signal to the control panel. The time setting can be adjusted by sliding switches 4 and 5.

Factory default

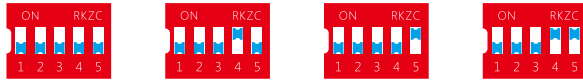

The alarm will be triggered when the light beam is being blocked for 0.3 seconds.
The alarm will be triggered when the light beam is being blocked for 0.6 seconds.
The alarm will be triggered when the light beam is being blocked for 0.9 seconds.
The alarm will be triggered when the light beam is being blocked for 1.2 seconds.

Note: The time setting has to be practical and in conjunction with detection area. It does not mean THE SHORTER THE BETTER.

Pairing

After the settings, pair the IR sensors with the control panel.

1. Put the transmitter circuit board and receiver circuit board face to each other in the same direction (the ↑ mark is in the same direction) and make sure the beam transmitters and beam receivers are face to each other.
2. Set the control panel in pairing mode (shown in the corresponding control panel user manual), trigger the IR sensors (block at least 2 beams and maintain this up to the pre-set time), and when a "beep" sound is heard, the system pairing is completed.
3. Arm the alarm system, trigger the IR sensors again, if the control panel goes off an alarm, means the IR sensors work normally.

Installation

Choosing place

1. The IR sensors are suggested to be installed on doors or windows. The gap between the transmitter and receiver should be less than 6 meters, and the control panel can receive the signal from IR sensors.

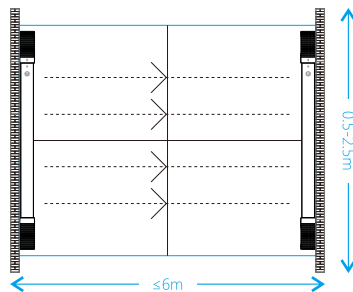

Note: The transmitter and receiver must be aligned to each other, and maintained the same distance from the ground.

2. Do not install the IR sensors at following locations:

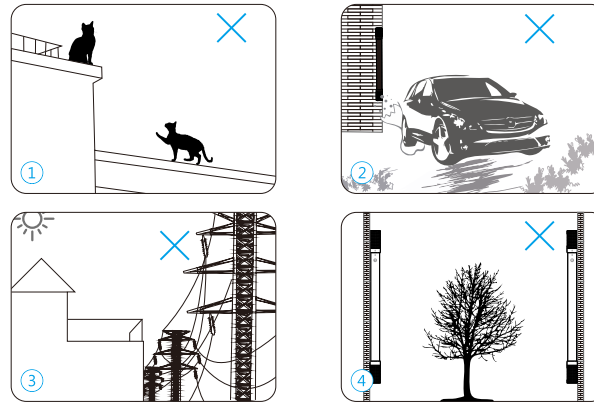

- ① Areas where pets are active
- ② Dusty and muddy areas
- ③ Within a 50 cm radius from power cables or network cables
- ④ Near trees or plants, as leaves or trunks may block the infrared beam

Fixation

1. Press the installation mode switch in the receiver circuit board, then put it into the beam bar. Insert the waterproof rubber plug and cover the installation cap.
2. Slide the transmitter's upper installation cap cover and lower installation cap cover. Put the transmitter to the target place and adjust the horizontal and vertical distance by watching the horizontal leveller in the upper installation cap.
3. Mark the screw holes of the transmitter, then use the hole punch to punch two screw holes, insert the expansion bolt then fix the transmitter with the screws. Cover the covers of the caps.
4. Adjust the receiver in the other side of the detection area. Make sure the buzzer rate is high, that is, the buzzer rate is every two "beeps" with a 1-second interval or three "beeps" with a 1-second interval. After adjusting, fix the receiver by following the upper step 2 and 3.

Buzzer frequency:

Every one "beep" with a 3-second interval, no signal
Every one "beep" with a 1-second interval, weak signal
Every two "beeps" with a 1-second interval, normal signal
Every three "beeps" with a 1-second interval, strong signal

*Generally, the IR sensors will automatically exit the installation mode in 30 minutes. However, when the receiver receives a weak but stable signal continuously for 5 minutes, the IR sensors will exit the installation mode. When the receiver receives a strong and stable signal continuously for 1 minute, the IR sensors will also exit the installation mode.

5. When the buzzer stops, arm the control panel, if the control panel alarms when walking in between the transmitter and receiver means the installation is successful and the system operates normally.

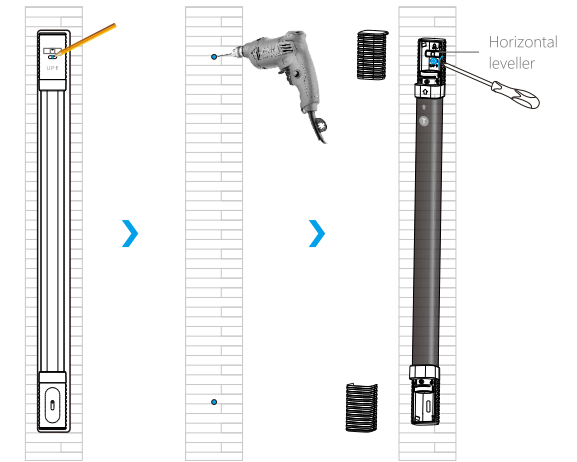

Precautions

1. This product aims to decrease the intrusion, but can not ensure 100% there will be no intrusions at all.
2. Please use the product by following the user manual.
3. Wipe the beam bars with a wet towel at least 3 months in turns, if there are any dirty dust, mud or heavy snow cover the bars, wipe them immediately.

Specifications

Detector infrared beam: 4 beams

Transmitter battery: 2 x CR123A 3V battery

Receiver battery: 3 x CR123A 3V battery

Standby time: 3 years

Standby mode power consumption:

Transmitter < 0.03mA;

Receiver < 0.11mA

Alarm mode power consumption: 0.04mA

Maximum detection range: 6m

Waterproof rating: IP66

Wireless frequency: 315MHz or 433.92MHz (±75KHz)

Wireless transmission distance: <80m (open area/no interference)

Case material: PC+ANTI-UV

Size: 42 x 47 x 612mm

CHUANGO®

产品型号	AID-420	部件名称	说明书
设计	林寿	材料	80克书写纸
印刷尺寸	285X210mm	成品尺寸	95X105mm
工艺	折页	版本	Ver: AID420-EN-V1.0

注:
四色、双面印刷