

2000±50mm

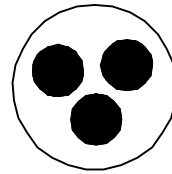

H05VV-F 3X0.75mm²

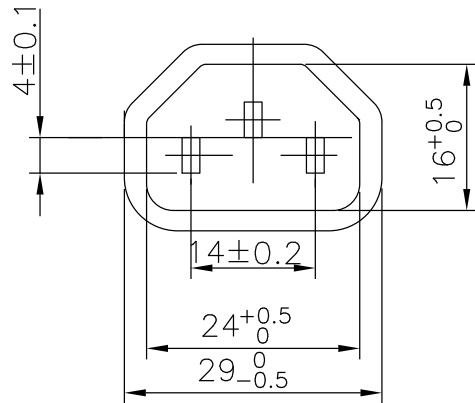
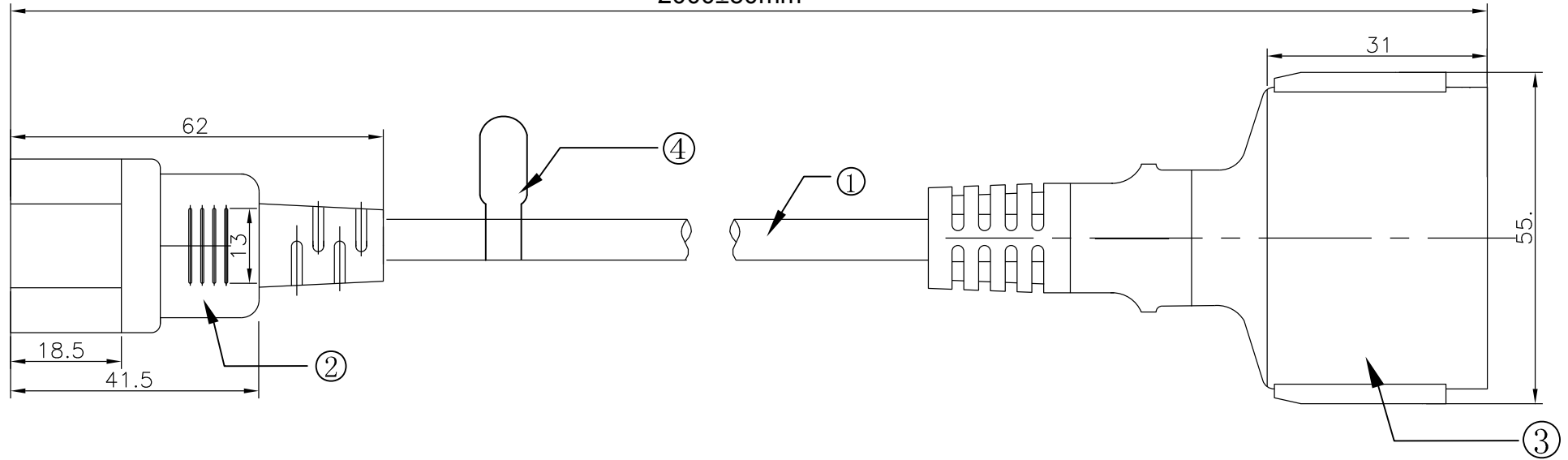
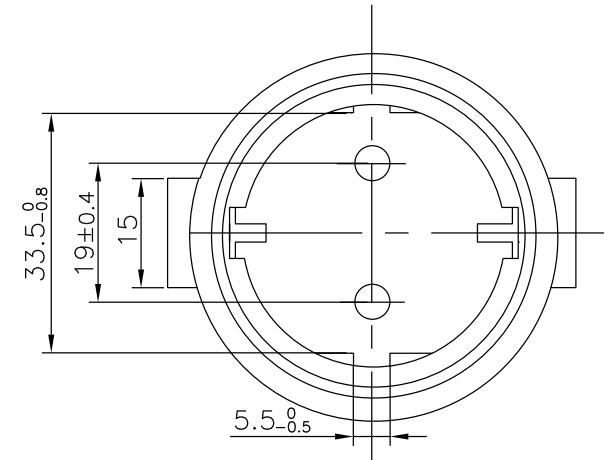

④	TAG	1PCS	DELTACO TAG
③	CEE7/4(Schuko)	1PCS	BLACK PVC
②	IEC C14	1PCS	BLACK PVC
①	CABLE	1PCS	H05VV-F 3*0.75mm ² BLACK PVC JACKET OD:6.7±0.2mm
NO.	PARTS NAME	Q'TY	SPECIFICATION

APPROVED	CHECKED	DRAWN	ITEM NO.	DEL-109P-200
			DRAW NO.	
			UNIT	mm
			SCALE	NONE

DESCRIPTION:
IEC C14 Male— CEE7/4(Schuko) Female
H05VV-F 3*0.75mm²
2m

