



Highlights

- Upgrade LCDs or TVs with improved ergonomic adjustability
- Constant Force (CF) patented lift-and-pivot motion technology produces smooth adjustment 
- Easily position your LCD for maximum comfort and productivity
- 5" (130 mm) height range easily meets the ergonomic height needs of the average male to the average female in seated applications
- Accommodates LCD weights of 6–16 lbs (2.7–7.2 kg)
- Sleek, durable, easy-to-clean plastic exterior
- The unique swivel capability allows you to spin the LCD stand 270° so a screen can easily be shared
- Easily attaches to LCDs that are VESA® MIS-D, 100/75, C compliant

Neo-Flex® LCD Stand

Affordable desktop ergonomics



More motion. Less effort. Feel the difference.

Add greater range of movement to your LCD display or TV with the Neo-Flex LCD Stand! This proven technology is now available as an accessory to displays. Previously, this design was only sold directly to LCD manufacturers (OEM).

Ergonomic experts recommend that the height of your LCD be positioned so that the top of the screen is at, or slightly below, eye level. This reduces fatigue and possible Musculoskeletal Disorders of the neck and shoulder. The Neo-Flex LCD Stand addresses this issue by allowing you to instantly set the height of your display.

With fingertip effort, you can raise or lower your display five inches (130 mm), pan right/left, tilt forward/back, or rotate 360° for portrait/landscape viewing. Ergotron's patented CF lift-and-pivot motion technology produces smooth, easy adjustment.



Position the height and angle of the LCD for maximum comfort and productivity. Rotate for portrait/landscape viewing.

Easily attach your LCD to the stand with four screws.

Constant Force (CF) patented lift-and-pivot motion technology provides smooth, easy adjustment.

Base uses little space yet ensures stability even as the monitor is adjusted.

Range of Motion:

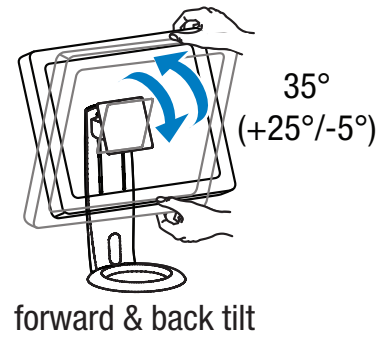
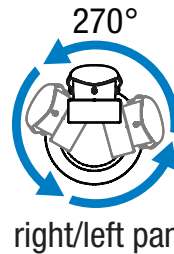
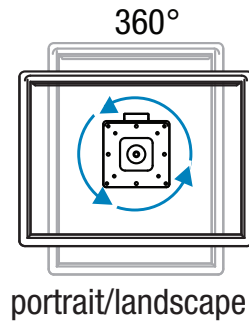
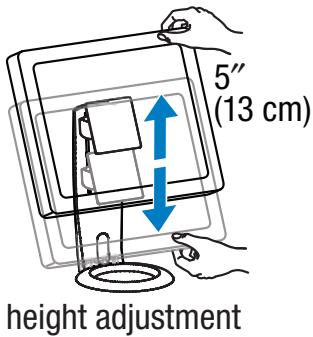

Basic Specifications:

Description: Neo-Flex LCD Stand 33-310-060 (black & silver)

Weight Capacity: 6–16 lbs (2.7–7.2 kg)
(excluding weight of any existing LCD stand)

LCD Interface Options:

- VESA FDMI MIS-D, 100/75, C
(hole pattern: 100 x 100 mm & 75 x 75 mm)

Note: VESA mounting interface location on LCD must be no more than one inch above or below LCD center-line to achieve ergonomic guidelines.

Warranty: 3 years

Shipping Weight: 6 lbs (2.7 kg)

Standards Compliance:

- VESA FDMI and VESA FPMPMI
- Meets UL Specification 1678 Tip Test for all weights of LCDs

NOTE: To learn more about how to set up an ergonomically correct workstation and the scientific basis for the design of this remarkable product, go to www.ergotron.com and click on Support Center, and then Ergonomics: download the white paper, "Design of an Ergonomically Correct DeskStand for LCDs."

© 2011 Ergotron, Inc. rev. 02/28/2011 e-05-067 Content is subject to change without notification

Americas Sales and Corporate Headquarters

St. Paul, MN USA
(800) 888-8458
+1-651-681-7600
www.ergotron.com
sales@ergotron.com

EMEA Sales

Amersfoort, The Netherlands
+31 33 45 45 600
www.ergotron.com
info.eu@ergotron.com

APAC Sales

Tokyo, Japan
www.ergotron.com
apaccustomerservice@ergotron.com

Worldwide OEM Sales

www.ergotron.com
info.oem@ergotron.com

